



The Fully Integrated Smart Home

The Complete Solution

w e l c o m e

t o

t h e

'W O W'

f a c t o r



The Fully Integrated Smart Home

There is so much hype surrounding 'Custom Installation', 'Smart Homes' and 'Home Automation' here we outlay a basic understanding of this terminology.

Generally speaking, the custom installation of any home automation will include anything that gives the end user control over the various technologies or 'sub-systems' found in the home; from security, lighting, heating, ventilation and air conditioning (HVAC); to more advanced hi-tech home theatre, motorised curtains and blinds, data and wireless communications networks.

No matter how much control integration takes place, if the end user cannot fully understand and operate comfortably a home automation system, then it's not really a 'smart' home at all. At **CAI Vision** we understand this fundamental principle, so we integrate a variety of disciplines that will compliment and enhance an end users lifestyle.

Most custom installers will design and commission the systems but 'will not' install the cable infrastructure or security disciplines, leaving the client to deal with yet another contractor, hence our mission statement '**The Complete Solution**'.

What **CAI Vision** do is unique in the custom installation market therefore we are the perfect partners to Architects, M&E consultants/contractors, Interior designers, house builders and self builders.



The Complete Solution

Why choose CAI Vision?

From the simplest to the most complex Home Automation solution, you will only ever need to deal with one Company **CAI Vision**. Which means we are always in control of your project ensuring we deliver what we agreed when we agreed and to a high standard of workmanship. We are Unique in that we are the only Company that delivers “**The Complete Solution**”



Experience

We have over 37 years experience in providing a complete and comprehensive range of: Audio Visual, Communications and Security solutions directly to end users, blue chip organisations and Government.



We have completed installations at: The British Museum, The Natural History Museum, The Tower of London and The Old Bailey. End users include: Nigel Lythgoe, John Cleese, Sir Peter Davis, Brit Eckland, Theresa Gorman, Des O'Connor and Michael Portillo, amongst many other well known personalities and celebrities.

We have worked on projects with Ove Arup, EMCOR engineering services, Wolff Architects, Ruskin Homes, Mansell plc, St James Homes and Manhattan Loft Corporation, and leading Interior Designers.



Custom Installation

CAI Vision is at the forefront of today's lifestyle technology

The home entertainment revolution has arrived and **CAI Vision** brings together all the knowledge and skill sets needed to offer the complete one-stop solution to the 'wow' factor! We give you simple, practical control of your music, movies, lights, temperature and security systems from anywhere in your home or anywhere in the world.



Your lifestyle system can include; Home cinema with multi-speaker surround sound will simply take your breath away. Multiple lighting scenes, automated curtains and blinds, games console integration for truly amazing video games, multi-choice TV channels, movies, internet, digital music, photo libraries and security system access, all controlled with the Graphical User Interface (GUI) of your choice. A colour touch screen, hand held remote, iPhone or iPad for example.



Whether you watch HD movies on a Plasma screen...



...hit a high score on your favourite video game like never before...

From your initial contact, through the design of your lifestyle environment to the completed installation, **CAI Vision** use highly qualified staff, backed up with our Care and Maintenance package affording you the peace of mind that working with professionals brings. We will liaise closely with your architect, builder, electrical contractor, interior designer or any other advisors you have.



The ultimate home cinema experience ... this really is the 'wow' factor

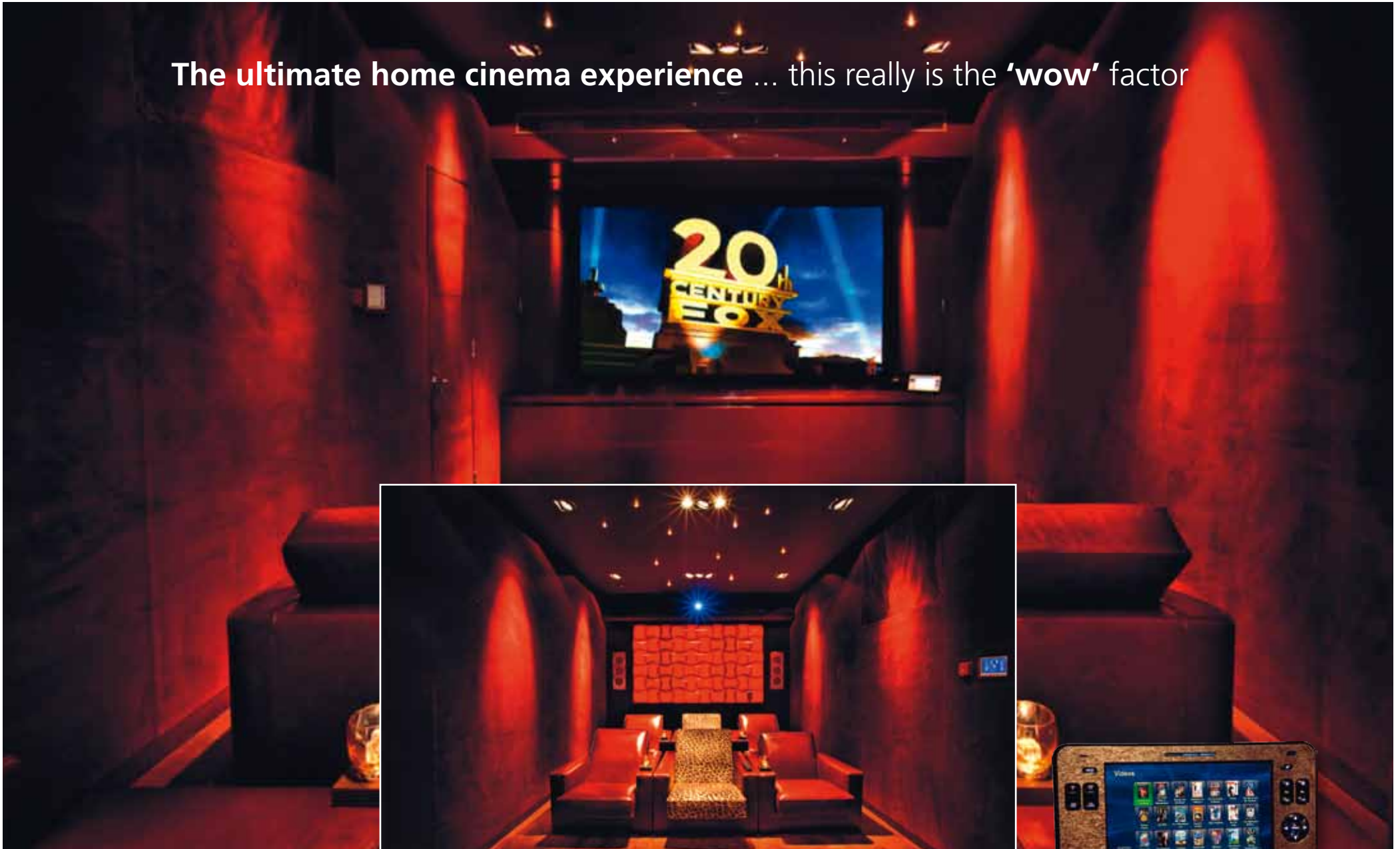

...or relax in your home cinema with crystal clear picture and surround sound, the CAI Vision experience delivers the 'WOW' factor.

The Complete Solution Process

We offer a straightforward and competitive service.

We will arrange an appointment for one of our Systems Advisers to meet you at your Home, Office or our Show Home. From the discussions that take place he will complete a Systems Design Brief taking into account your estimated budget. We will then produce a Custom Installation Proposal and Estimate.

Upon acceptance we produce a full systems design pack including a detailed specification, schematic drawings and cable schedules. A project manager will oversee your entire project through to completion.

A structured project plan and 'program of works' will be agreed with you, we will then liaise with your Architect, Builder and Electrical contractor for a full review of your installation including equipment locations, cable routes and cut-outs to ensure we deliver you 'The Complete Solution'.

'First Fix' cabling is undertaken at your property.

Before 'Second fix' is carried out, we will inspect and test all cables.

Equipment is ordered and delivered to our 'test and build' facility, the equipment is then pre-staged before delivery to site where our engineers Install, Commission and Complete final programming to suit your personal requirements for example, lighting scenes can be created to suit your lifestyle.

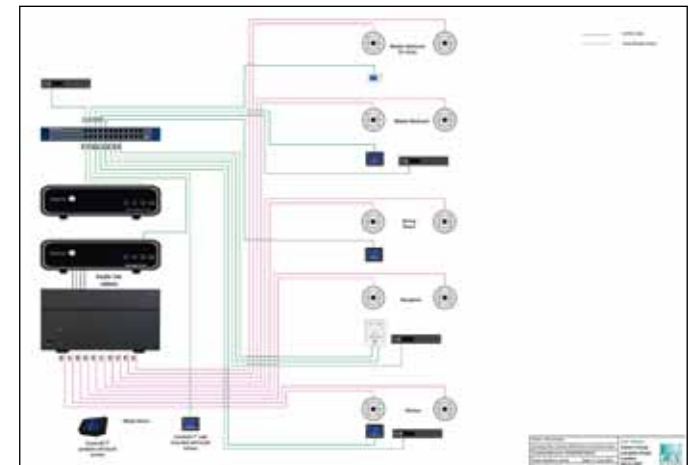
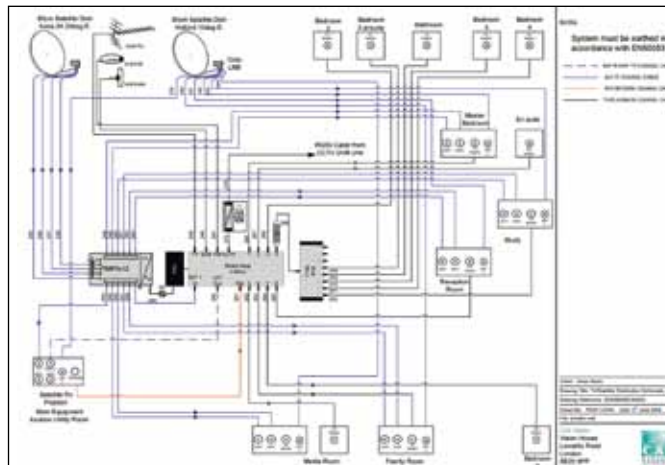
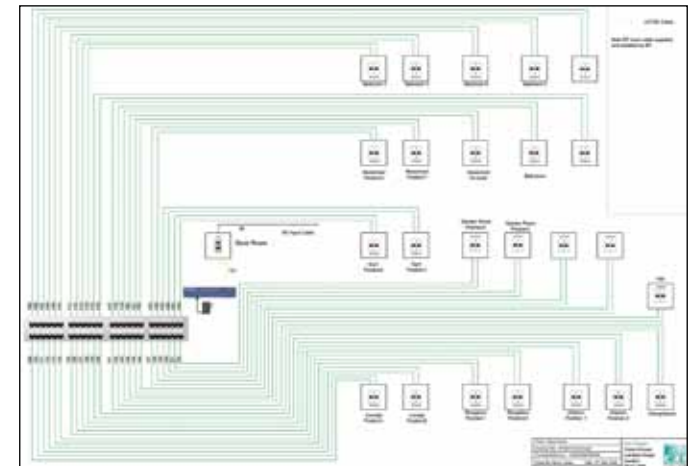
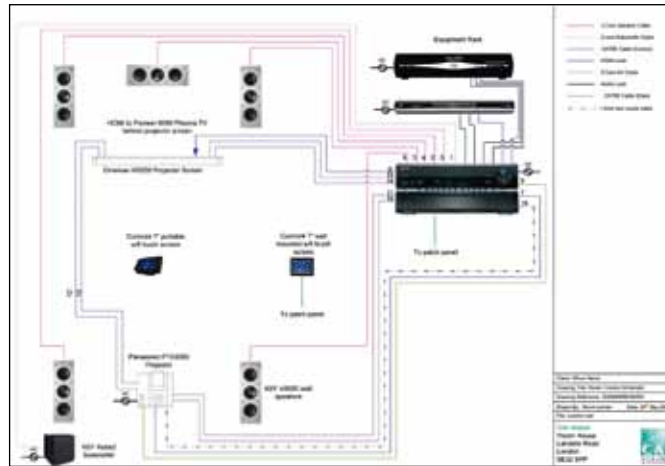
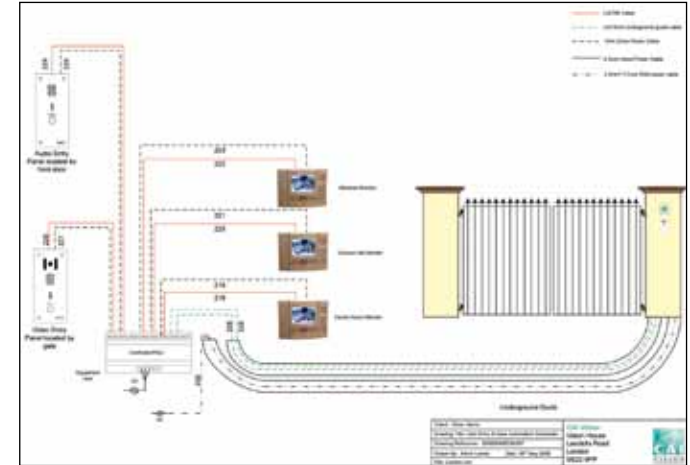

A complete demonstration of your system is undertaken together with a visual inspection of the entire installation, we will then instruct you on how to operate all aspects of your Custom Installation correctly. The system is then handed over to you as a completed project.

A comprehensive "hand over" pack is presented containing all of the system manuals, warranty and maintenance contract details.



Turn down the lighting, select a channel, breath out, lean back and relax... 'wow'.



Make socialising special with instant control over your 'lifestyle' technology...set the right mood and 'wow'

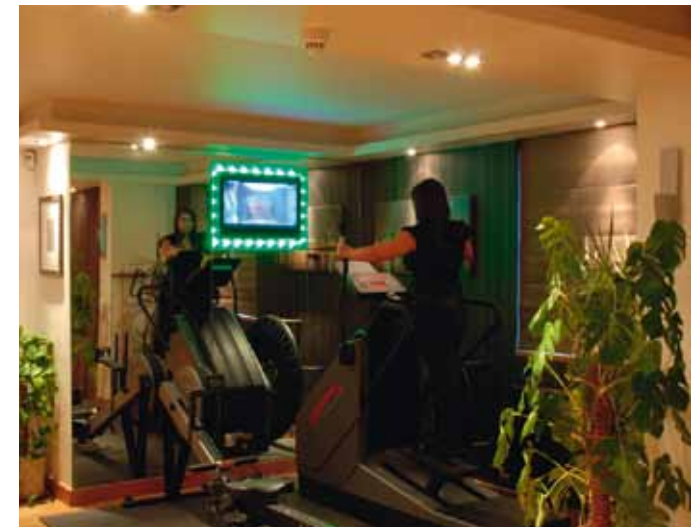

Communications

Telephone, Internet and Data

Designing, installing and integrating all these technologies takes a very high degree of professional care and understanding. **CAI Vision** is able to supply all of the specialist skills needed to complete a fully integrated modern communications system for your home.

CAI Vision has built an enviable reputation for completing these complex installations to a high degree of customer satisfaction, with the added security of knowing that we supply a full maintenance and customer support service.

Integrated Reception Systems

Integrated Reception Systems (IRS) provide all current forms of terrestrial and satellite TV, Radio and CCTV media to multiple dwellings (MDU) and multiple rooms in a single dwelling.

IRS were developed by Sky and Philips. Our systems designer Kevin Lomax (an employee since 1983) designed and project managed the pilot installations.

Our MDU (IRS) clients include Local Authorities, Housing Associations, Managing Agents, Property Developers, Architects and Consultants.

CAI Vision has been at the forefront of audio and television distribution systems since 1973. In today's digital age we are market leaders in the supply and installation of:

- Telephone, Internet and Data
- Integrated Reception Systems
- Television/Video Signal Distribution
- HDTV multi-room distribution
- Audio/Video Door & Gate Entry
- Public Address
- Professional Sound Systems



Multi-room Television & HDTV Distribution

At **CAI Vision**, we want you to get the best out of your Audio Visual (AV) equipment. Never has this been more so than with the recent introduction of HDTV.

There are many ways in which one can receive an HDTV signal. In the UK the three primary options are SkyHD+, Cable & Freesat HD. Top manufacturers such as LG, Panasonic & Sony are at the very forefront of this technology and are already making TVs with freesat HD built-in. Therefore, just like with digital freeview, it is only a matter of time before freesat HD becomes standard across nearly all HDTV's.

Because of this, **CAI Vision** recommend that all new & re-wired TV installations be truly HD compatible and include sufficient Cabling to receive freesat HD, internet and much more at ALL TV points throughout your home. Not only do we understand what people need from their HDTVs today, but we have a fair idea about what you are likely to need in the not too distant future. Therefore, all of our HDTV wiring solutions feature no less than SIX high-grade structured wiring cables to each TV point. Anything less would be a compromise!

Furthermore, as experts in TV distribution, all of our typical HDTV solutions offer numerous upgrade paths, should you wish to send HDTV signals locally around your home. (e.g. Connect SkyHD/DVD/BluRay to many TVs at the same time – all in HDTV quality).



Fire and Security

Your number one priority is to keep your family and property safe

CAI Vision is a "NSI Gold" certified installer. We have been assessed and satisfy the requirements of the NSI Gold scheme with respect to the design, installation and maintenance of electronic security systems including:

- Intruder / Fire Alarms
- Access Control
- Intruder Alarms
- Fire Alarms
- Closed circuit TV
- Central Station Monitoring for Fire, Security and CCTV
- Access Control
- Door Entry
- Automated gates



As an **NSI (National Security Inspectorate)** approved company we:

- have been thoroughly security vetted
- are rigorously inspected twice a year to ensure they are maintaining standards in both the quality of installation and how they are run as a business
- are properly insured
- complete a thorough security survey of your property
- install reliable, up to date equipment

- operate a 24 hour call out service (and respond within 4 hours)
- issue you with a Certificate of Compliance for your alarm
- meet the relevant British and European Standards
- increase the security of your Intruder / Fire Alarm and, or CCTV cameras with our 24hr monitoring station



Intruder / Fire Alarm

Our Monitored Alarms provide a more effective security installation than traditional bells only alarms. Research has shown that most people ignore a ringing bell. However, with a monitored alarm system, a signal is sent to our Alarm Receiving Centre when the system is activated. The status of the alarm is then checked and where appropriate, the emergency services are contacted.

Closed Circuit TV

Since 1973 **CAI Vision** has been a market leader in television and video signal distribution. It is this know-how that guarantees excellence with the design and installation of CCTV systems, resulting in superb, high quality visual images.

We can integrate CCTV with access control, intruder and fire alarms, and computer networks, so you can view and operate security systems from a laptop or mobile phone, anywhere in the world.



CAI Vision installs CCTV systems into a variety of residential, commercial and industrial premises, in addition to high profile institutions such as the Natural History Museum and the De Beers Diamond Collection. There are currently more than two thousand retail and

commercial customers that operate **CAI Vision** CCTV systems.



A range of attractive video monitors enable you to welcome guests at the front door and gate



CCTV, Video Door and Gate Entry with Automated Gates ... take a look inside



A stunning lighting operation to set the mood for every occasion

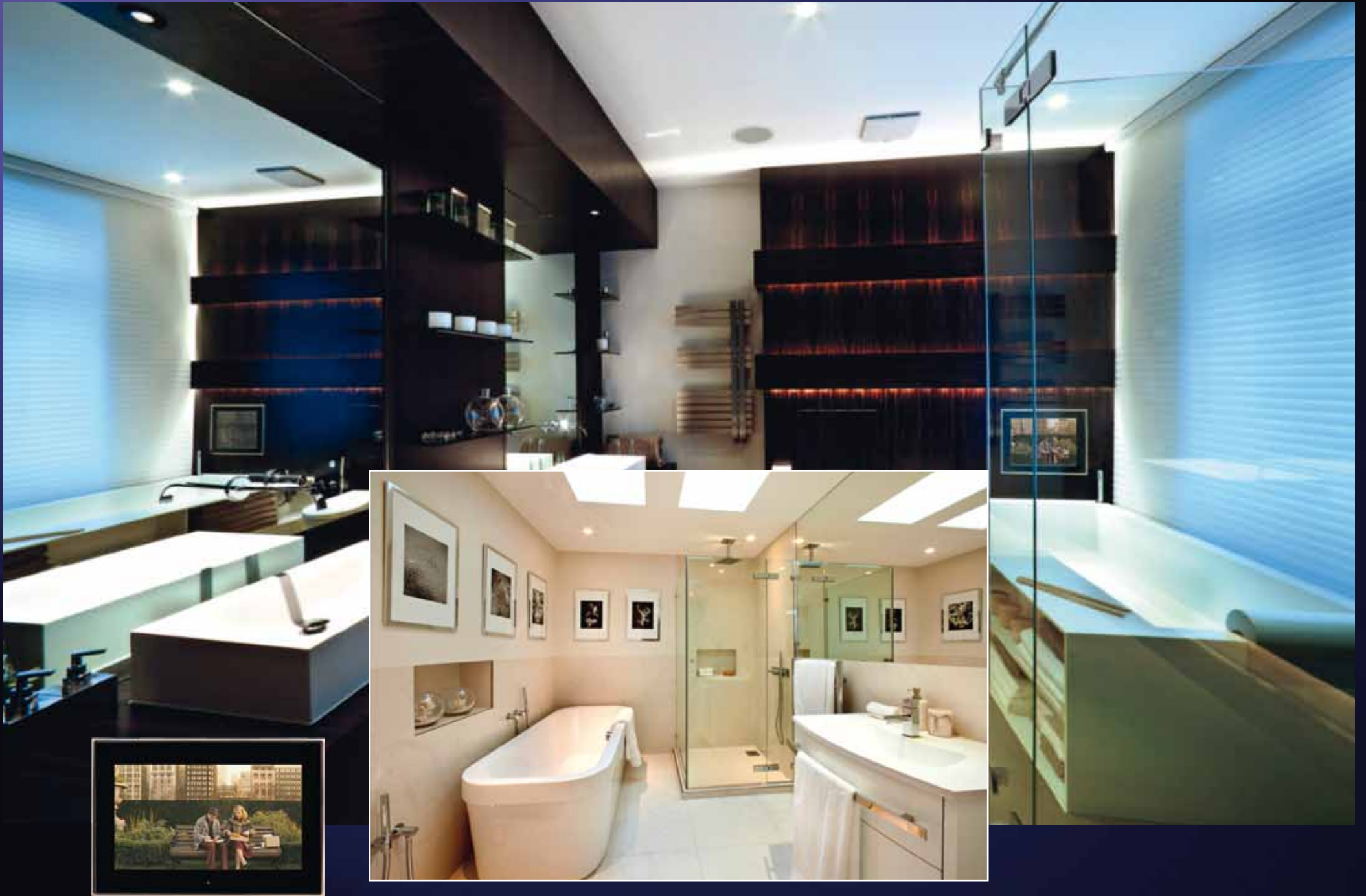

Sound and vision whilst you relax



The Complete Solution for the fully Integrated Smart Home

Home Automation & Systems Integration

Multi-Room Audio-Video

Home Cinema

Television, Radio, Media and Satellite Distribution

Automated Lighting, Curtain and Blind Control

Telephone, Internet and Data Network

Intruder Alarm

Fire Detection

Closed Circuit Television

HVAC

Door/Gate entry and Automated gates

Electrical Installation, Inspecting and Testing

Professional accreditations

CEDIA - The Custom Electronic Design & Installation Association. For Home Technology Systems Integrators.

NSI Gold - The National Security Inspectorate, authorises our Intruder Alarm, CCTV and Access Control installations and service.

NICEIC - National Inspection Council for Electrical Installation Contracting. APPROVED CONTRACTOR.

Sky – As an authorised Sky installer we connect the TV/Satellite distribution system to the Sky network.

SAFEcontractor - Approved guarantees that we operate with the highest standard of health & safety competency.

ISO 9001 - International Standards Organization; this accreditation provides clients with the assurance that we adhere to defined quality standards.



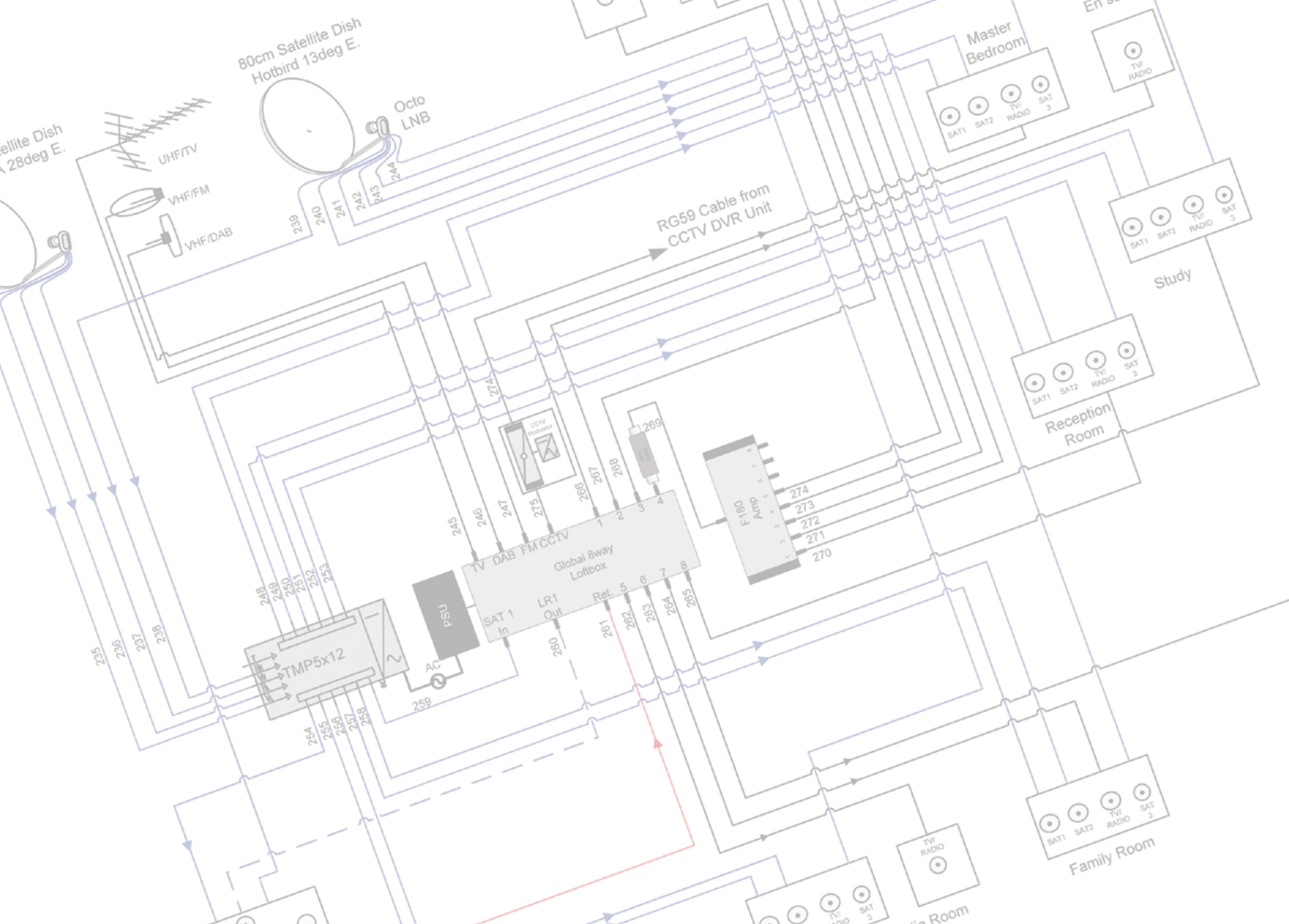



CAI Vision

Unit 1, 1a Carberry Road, London SE19 3RU

T · 020 8768 2800 F · 020 8768 2200

E · enquiries@caivision.com

www.caivision.com

